



Asian Machinery U.S.A., Inc
 3 SW 129TH Avenue, Suite 208
 Pembroke Pines, FL 33027, U.S.A.
 Tel: 305-594 1075



MODELO: VMGL2160
 TRITURADORA



ESPECIFICACIONES

DIAMETRO DE ROTOR	Φ 284
VELOCIDAD DE EJE	15 R/MIN
CUCHILLAS DE ROTOR	30 PCS
ESPESOR DE LAS CUCHILLAS	20 MM
POTENCIA DEL MOTOR PRINCIPAL	5.5 + 5.5 KW
PESO	2200 KG

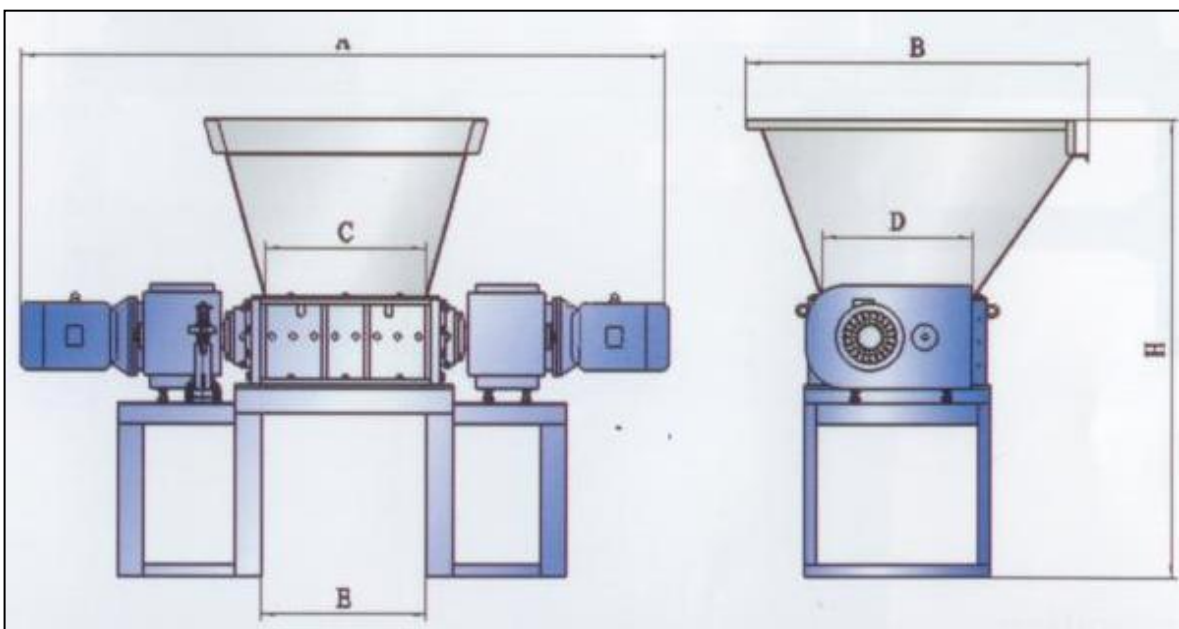

A (MM):	2590
B (MM):	1260
C (MM):	604
D (MM):	510
E (MM):	650
H (MM):	2000